

DON'T SEARCH. FIND!

The Leica DVM6 digital microscope

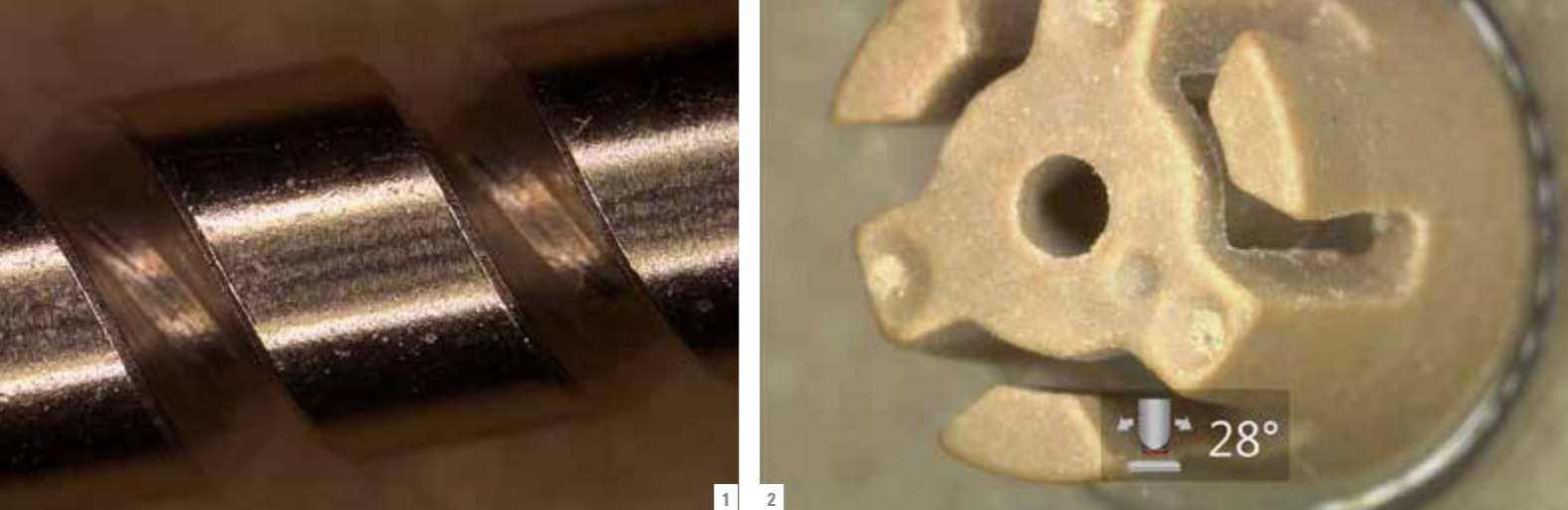



**Don't search. Find!**

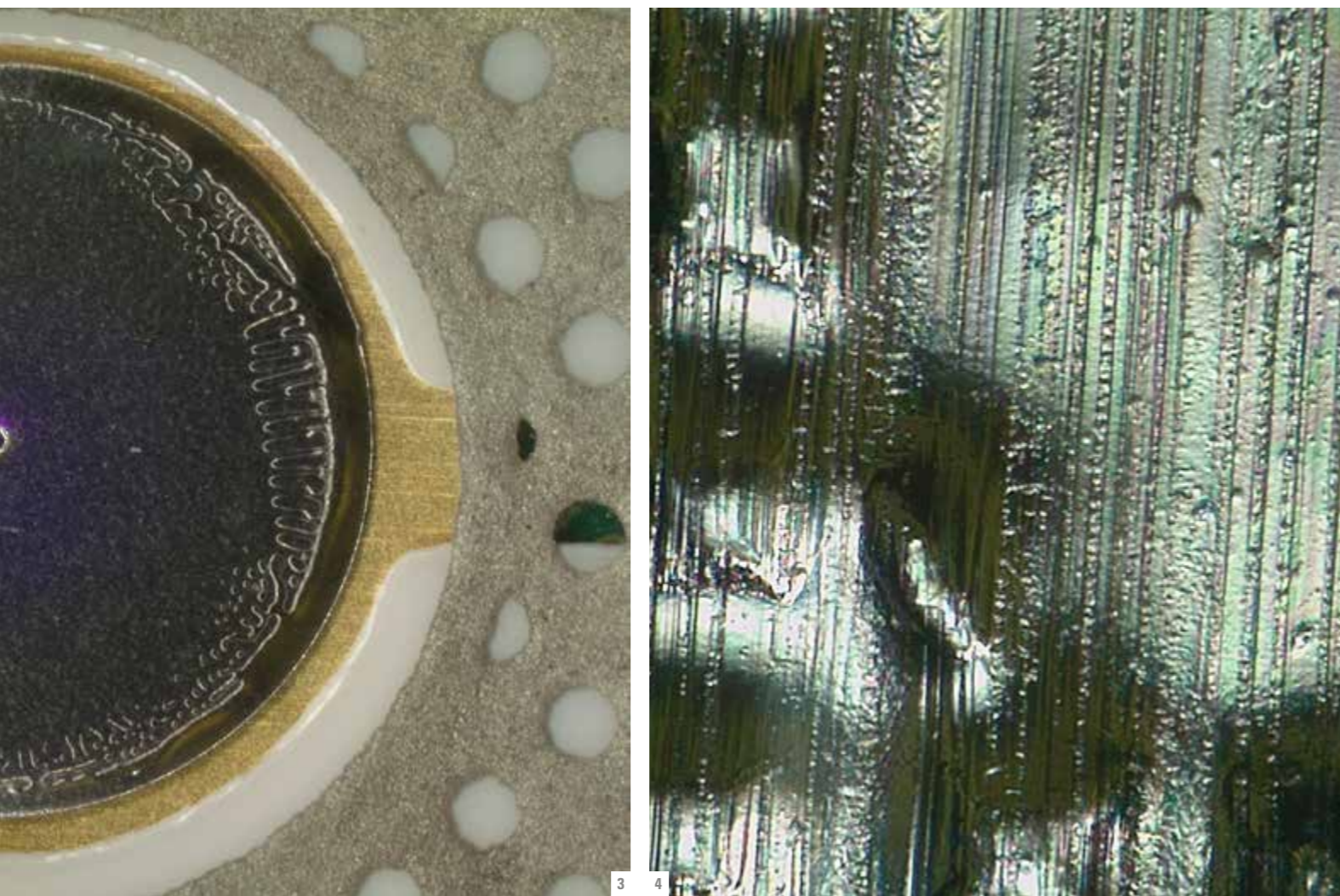

## PUT AN END TO LONG SEARCHES

The Leica DVM6 digital microscope solution is fast, reliable, and easy to use – no matter if you work in quality assurance, failure analysis, research and development, or forensics.

Anyone can be an imaging specialist with the DVM6.

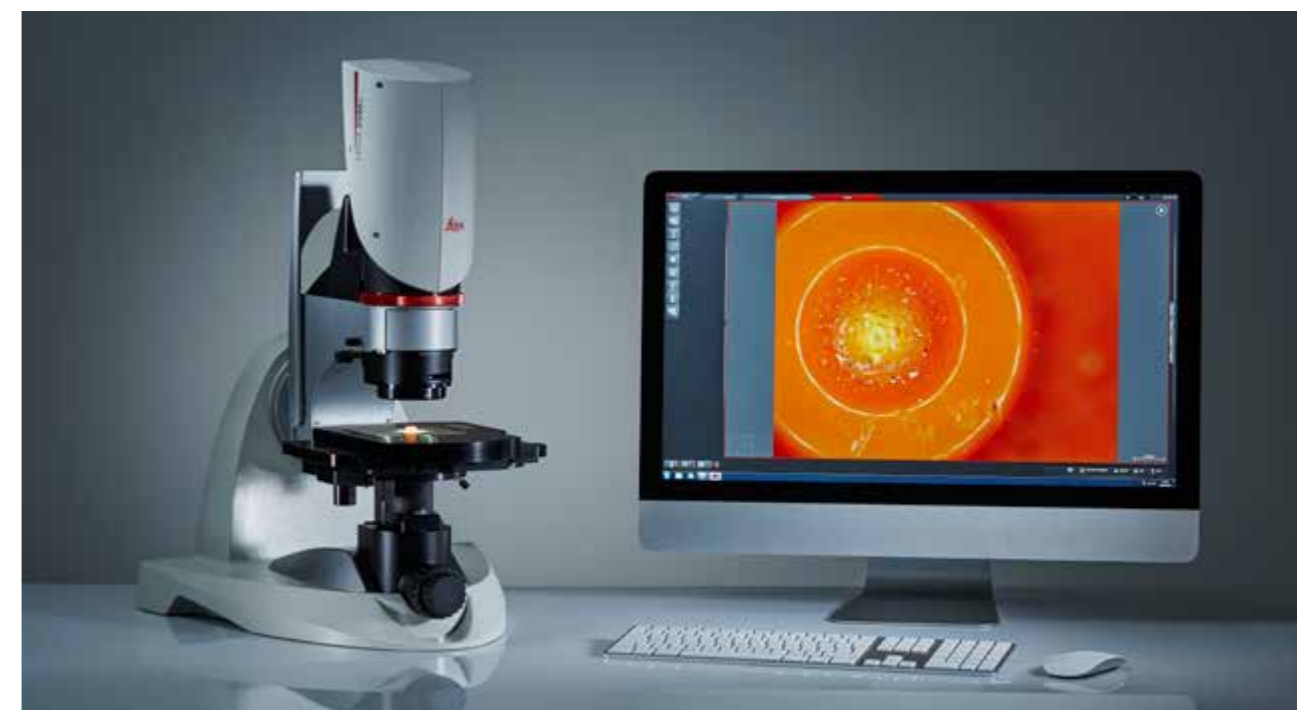

### EASE OF USE

One step from macro to micro:

- Change magnification fast, thanks to a wide 16:1 zoom range
- Work seamlessly from 12x up to 4,740x magnification\* and change the objective with one hand
- Stay focused, always, with easy one-handed tilting

\* based on 1:1 display (10-megapixel)

### BRILLIANT IMAGE QUALITY

See more with crisper images:

- Discover more details with the high-resolution 10-megapixel camera
- See images in best resolution with top-notch optics
- Get the best image with one click via the Image Preview function

### IMPRESSIVE RESULTS

Rely on intelligent automation:

- Intelligent software – a measurement tool for every need
- One click report for 2D and 3D measurements
- Reproduce results easily – system settings are always saved with every image, e.g., position, magnification, illumination

1: Spindle - 63x with HDR, ringlight and coax  
2: Injection moulding - 70x, tilted

3: Membrane switch - 60x  
4: Embossed Al-paper - 730x, food packaging



## EASE OF USE

From the big picture to the smallest details in an instant. Even an objective change does not interrupt your workflow. The Leica DVM6 works straightforward and saves you time inspecting various samples. This solution enables all users to start working right away with minimal training.



### OBJECTIVE CHANGE: PLUG AND SEE

Simply slide in the objective to change to a different magnification. It is a simple one-handed movement while in operation. No additional adjustments, e.g., software setting, cabling, need to be made – parfocal objectives keep the sample in focus.

#### PLANAPO OBJECTIVES:

- PlanAPO FOV 43.75: The objective for maximum overview (with 45 mm FOV diagonale)
- PlanAPO FOV 12.55: The workhorse with big magnification range (40x-675x) at high working distance (33 mm)
- PlanAPO FOV 3.60: Ideal for maximum resolution (up to 2,350x at 425 nm resolution)



### TILTING STAND: CHANGE YOUR PERSPECTIVE

You can easily tilt the observation angle with one hand. Just concentrate on the monitor to study the sample. By default, the tilting axis is aligned to the focus point so you can see your sample, always in focus, at any angle from - 60° to + 60°. Rotate the stage and explore the sample from completely new perspectives. This helps you to find the details that you are looking for.



### 16:1 ZOOM RANGE: EXTREME MAGNIFICATION VERSATILITY

Using only one rotational movement, you can see 16 times more with up to 2,350x magnification. The actual magnification of the PlanAPO-corrected zoom optics is displayed on the monitor. This gives you a perfect reference of the imaging conditions.

#### BENEFITS OF PLANAPO OPTICS:

- Maximum optical correction power
- Highly detailed images sharp up to the border area
- No color fringes over zoom range

### AUTOFOCUS: READY – STEADY – SHARP\*

Choose between autofocus and continuous autofocus for your individual tasks. The autofocus of the Leica DVM6 can be applied to any image region (ROI). Stay focused with the DVM6 unique continuous autofocus.

\* only for DVM6 S/A



### STAGE POSITIONING: INTUITIVE NAVIGATION

Get the best of both worlds: fast manual stage movement combined with precise motorized positioning. Instantly reach any point with a 70 mm x 50 mm travel range.



1: Automotive component 1:1  
2: Automotive component 16:1

# BRILLIANT IMAGE QUALITY

To obtain really crisp images you need outstanding optics, a variety of illumination options and a high-performance camera that will capture images in natural colors. The Leica DVM6 offers all that!



## TOP-NOTCH IN OPTICS

A digital image can only be as good as the system's optics. Leica Microsystems is a pioneer in the optics industry and among the world leaders in precision micro-imaging. The company history and the passion for delivering sample images in the highest degree of detail and clarity go back more than 160 years. Leica engineers have eliminated optical aberrations and constantly pushed for better resolution – this can be seen immediately with the DVM6.



## ULTRA-RESOLUTION CAMERA FOR FAITHFUL RESULTS

Unlike digital microscopes that utilize interpolation and time-consuming pixel-shifting, the heart of the DVM6 contains a native 10-megapixel camera. Very fast live image display at more than 30 frames per second allows you natural hand/eye coordination ensuring comfortable operation. Integrating the camera into the zoom module provides the perfect protection against contamination.

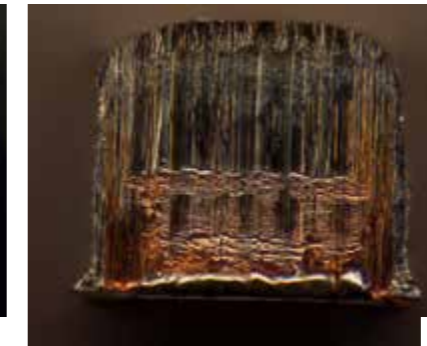

## ILLUMINATION: REVEAL HIDDEN DETAILS

Your choice of illumination determines what you see. Depending on the sample, application, and task, you can choose from different integrated LED illumination options. Use the ringlight – either fully or partially – on textured surfaces, or select the coaxial illumination for flat, reflective samples. You can also combine illumination modes and reveal details you have never seen before.

### COAXIAL LIGHT PROVIDES:

- Quarter wave plate control for light/dark control when viewing flat, reflective samples
- Relief contrast for accentuating slight unevenness, such as scratch marks

- 1: Ringlight all four segments
- 2: Adjustment relief contrast
- 3: Metal cut (Sn-plated copper) - 650x, relief contrast
- 4: Metal cut (Sn-plated copper) - 650x, ringlight segment
- 5: Adjustment quarter wave plate

# IMPRESSIVE RESULTS

With the Leica DVM6 you can rely on intelligent automation: Reproduce any image in its entirety with all relevant or selected parameters. The digital microscope not only produces crisp images quickly and saves all system settings for you automatically. This helps you to speed up many processes throughout your work day, especially repetitive tasks. And if your microscope is shared among several operators, the encoded functions ensure that every user delivers the same quality of data.

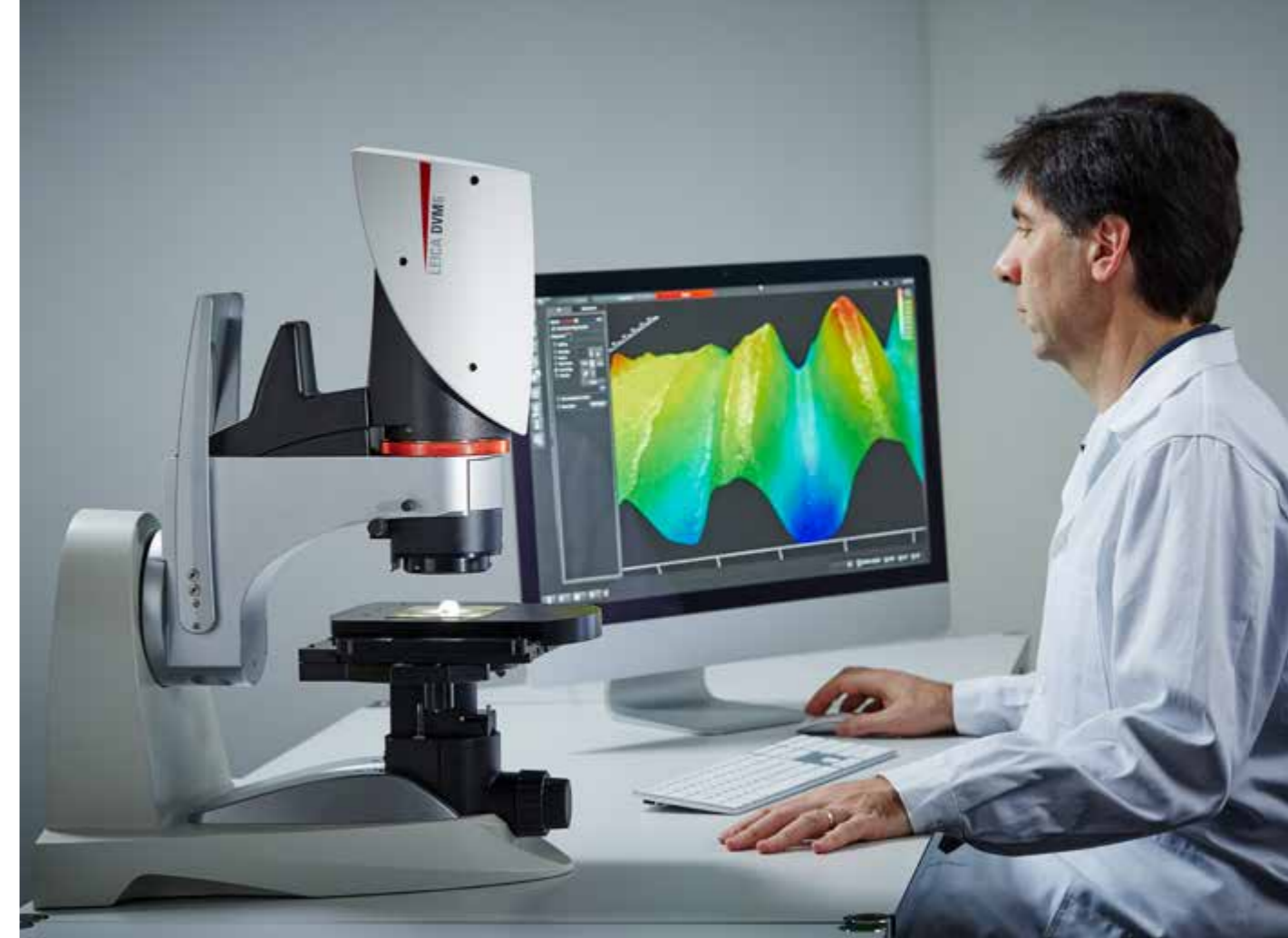

## ENCODED SYSTEM: MINIMIZE ERRORS

To help prevent errors, all critical functions of the Leica DVM6 are monitored with sensors. The encoded elements include:

- XY-stage, manual or motorized
- Focus drive (coarse/fine), manual or motorized
- XY-stage rotation, stepless adjustment from -180° to +180°
- Tilting angle, continuous adjustment from -60° to +60°
- Continuous magnification
- Objective type
- Illumination type and intensity
- Optional accessories

## EFFICIENT DOCUMENTATION WITH ONE CLICK

You can easily create 2D measurements, 3D analyses, and annotations in the image with the LAS X software. Export results to an Excel report template with a single click. You can rely on correct measurements for each image, since zoom positions and objective are seamlessly read out and correct calibration is applied. Additionally the total magnification is always saved and displayed with each image.

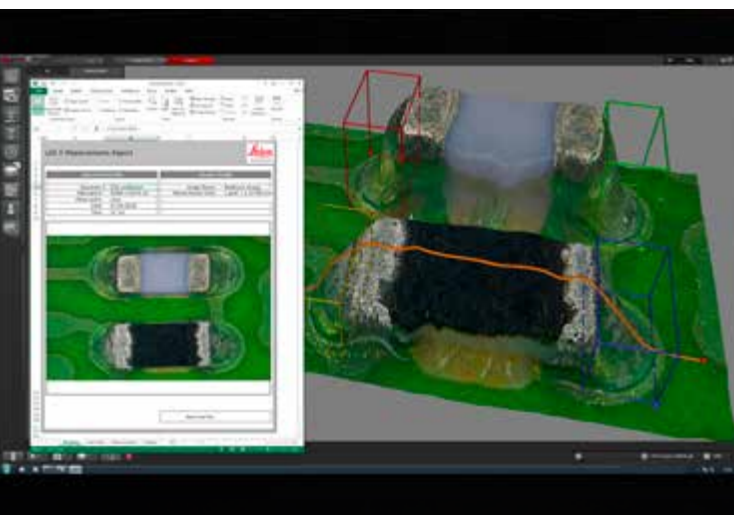

## INTELLIGENT SOFTWARE: YOUR AUTOPILOT

Leica Application Suite (LAS) X supports all advantages of the Leica DVM6: fast, easy, and reliable. Practical functions help you with your every day work. You may have some questions already in mind, such as:

### Can I easily improve the image of my sample?

Yes, the Image Preview provides you six different suggestions.

### Can I reproduce previous image conditions?

Yes, just select an image and have Parameter Recall reproduce all settings.

### Can I handle samples with very bright reflections?

Yes, High Dynamic Range (HDR) gives you a balanced image, showing optimally exposed bright and dark sections at the same time – even in the live image.

### Can I create high resolution 3D images over a large sample area?

Yes, LAS X allows you to extend 3D images over the full xy-scanning area with virtually no size limit.

## IMAGES WITH HIGH DEPTH OF FIELD MADE EASY

- **Z-Stack:** The system detects a series of images in various focal planes and, from the image stack, automatically calculates an all-in focus image, in which all elements are displayed in sharp focus. This all-in focus image contains height information for each pixel. Thus it can also be viewed as a 3D model to analyze the structure of the surface and carry out measurements.
- **LiveImageBuilder:** If no 3D image is required, LiveImageBuilder can be used to generate images with high depth of field in real time. Here, the operator starts the image capture and can see on the screen how the image is composed while moving through the focus range.
- **Unique Digital Fusion:** Gives the Leica DVM6 another one-of-a-kind option for generating best-in-class pictures. Digital Fusion technology combines high-resolution with maximum depth of field (typically a trade-off with other systems) for the perfect image. This provides an advantage for viewing different angles.



## FIND YOUR CONFIGURATION

To help you find the solution that best fits your application and budget needs Leica Microsystems offers the Leica DVM6 in three different configurations.

Do you need high-resolution images and application versatility?

### LEICA DVM6 C

- Manual xy-stage is coded for measuring stage travel
- Manual focusing with integrated measuring system
- Software package including image capture and image management, 2D measuring and explanatory notes, LiveImageBuilder for xy panoramas and pictures with high depth of field

Are you also looking for multi-focus images and 3D-analysis?

### LEICA DVM6 S

- Manual xy-stage is coded for measuring stage travel
- Motorized focus for automatic 3D image-stacking (can be focused manually also)
- Software package including image capture and image management, 2D measuring and annotations, LiveImageBuilder for xy panoramas, images with high depth of field, autofocus function, multi-focus images with 3D view and 3D measurement

Would you also like to scan larger areas in high resolution?

### LEICA DVM6 A

- Motorized precision xy-stage with manual coarse positioning
- Motorized focus for automatic 3D image-stacking (can be focused manually also)
- Software package including image capture and image management, 2D measuring and annotations, images with high depth of field, autofocus function, multi-focus images with 3D view and 3D measurement, automatic xy panoramas in 2D and 3D

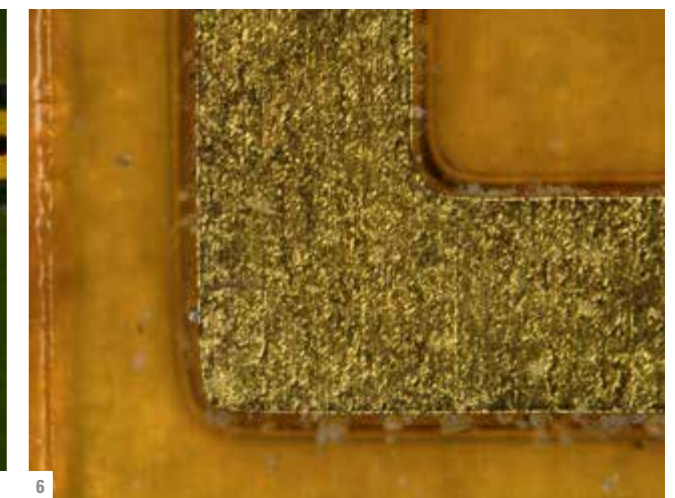
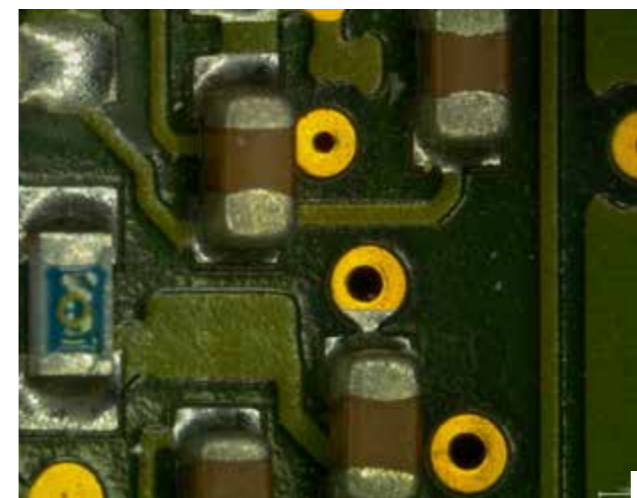
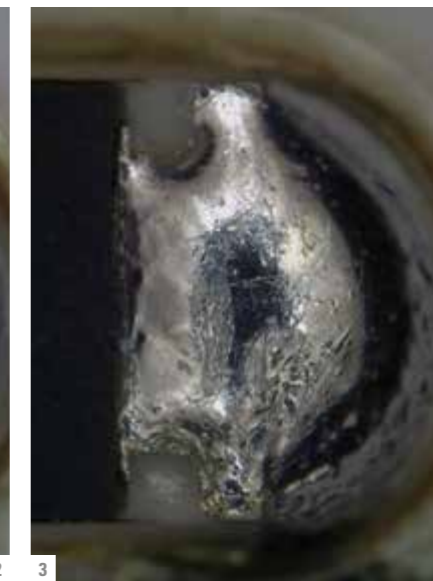
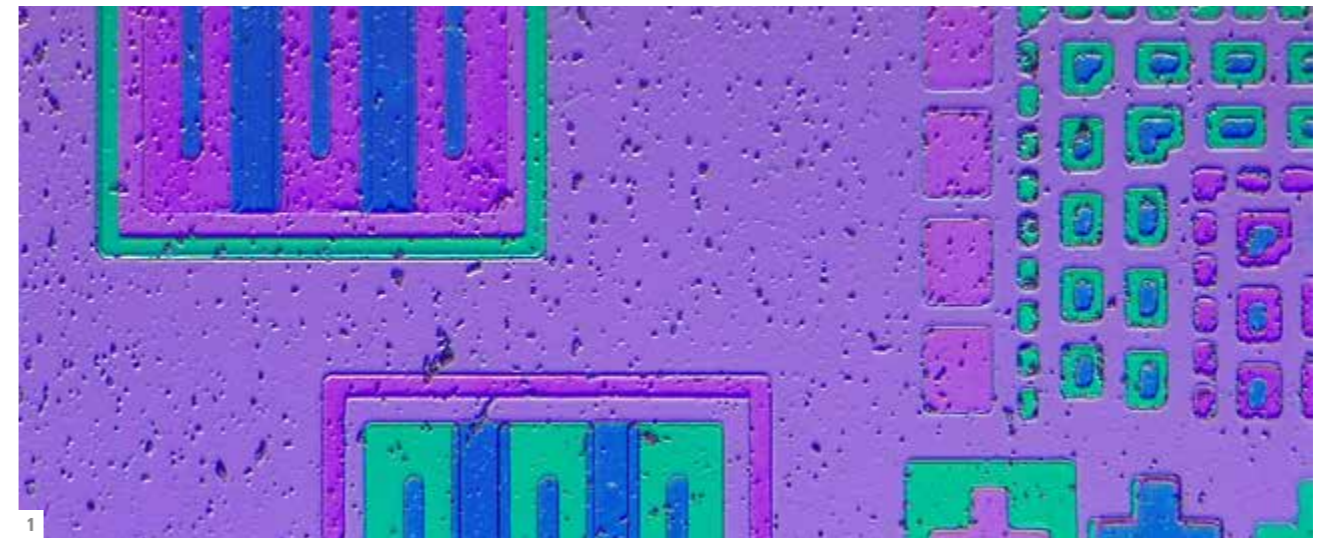

1: Wafer - 750x, coax open, relief contrast  
2: Solderjoint - 175x, ringlight  
3: Solderjoint - 175x, ringlight and diffusor

4: Filter grid - 200x, backlight  
5: PCB - 70x, 14° tilted, ringlight  
6: Bondpad - 360x, Au-plated, automotive electronics

# SAY YES TO THE LEICA DVM6 AND ...

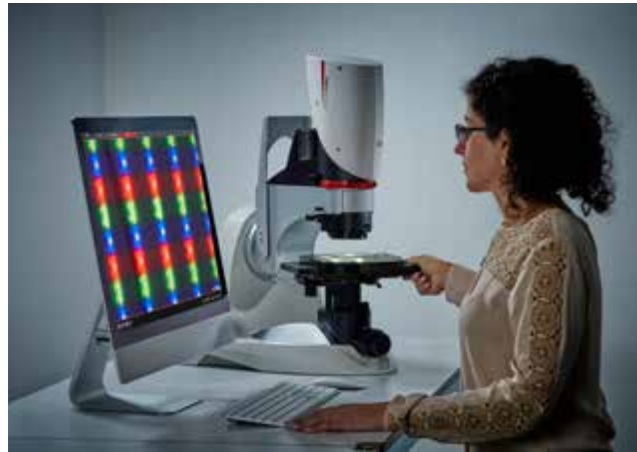

## ... BENEFIT FROM VERSATILITY

- Three configurations for individual application needs and budgets
- One single system to accommodate various sample types and sizes to 2 kg and travel range of 60 mm
- No need for dedicated microscopy experts

## ... MAKE MICROSCOPY EASY FOR EVERYBODY

- Robust instrument easy to use
- User interface is self-explanatory
- Software features for recurring tasks assure same data quality from user to user
- Flexibility and suitable ergonomics for individual microscope work space arrangements



## ... OPTIMIZE REPORTING

- Easy reports with preconfigured excel templates
- Reliable inspection results from user to user and sample to sample
- Reports with comprehensive analysis and measurements for 2D or 3D surfaces



## ... GET A SYSTEM SOLUTION THAT PAYS OFF

- Windows-based system, easy network integration, and compatible with most PC hardware brands
- Out-of-the-box solution, with only one power cord and USB cable, ready to run and maintenance-friendly
- Minimal training requirements and training on the job is possible
- LAS X updates or additional software modules keep your system up-to-date

- 1: BGA Solderball with LAS X measurement in 2D and 3D  
 2: Cr-oxide - 280x, coaxial illumination  
 3: Leadframe - 13x  
 4: Detail plastic beverage packaging - 140x

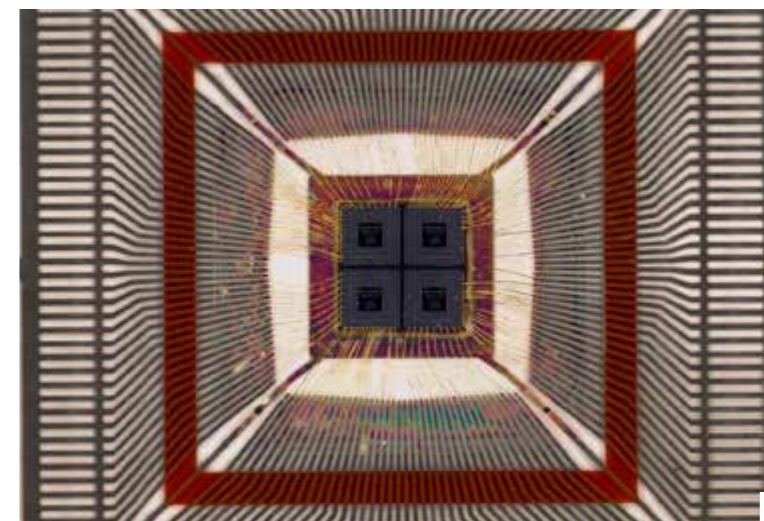
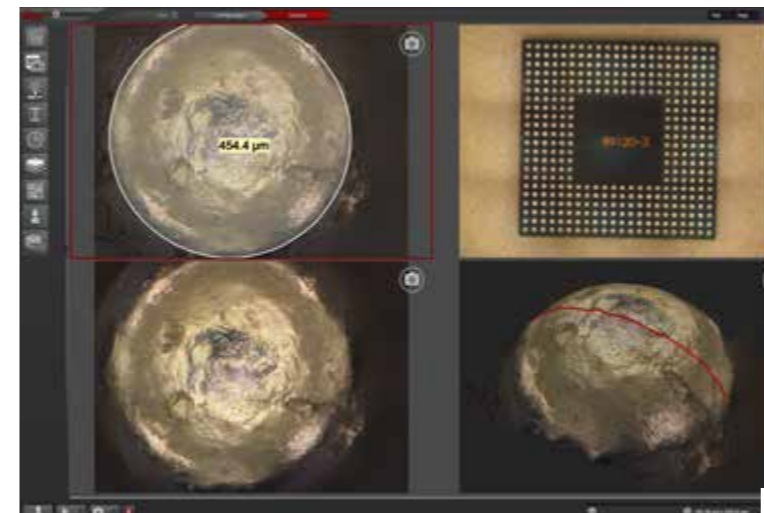

# SYSTEM OVERVIEW AND SPECIFICATIONS



## LEICA DVM6 DIMENSIONS

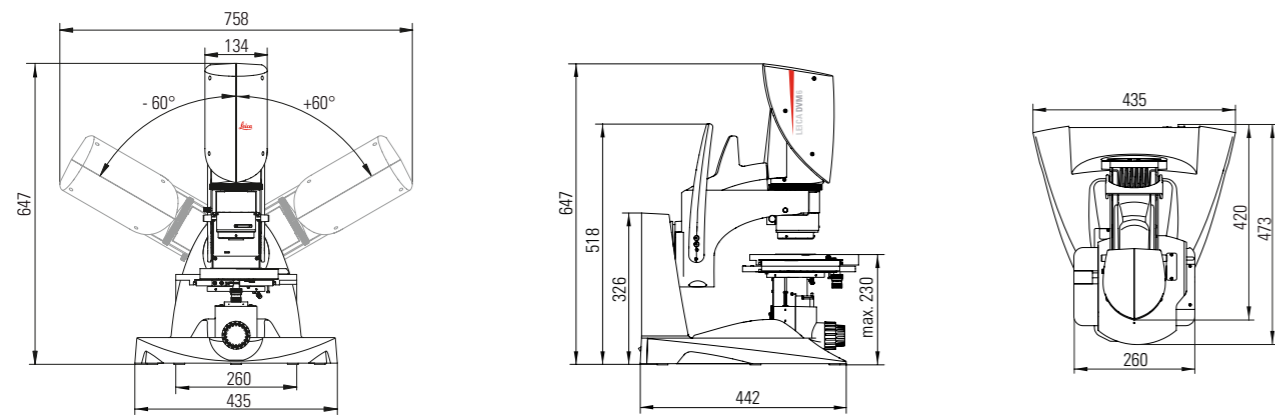

Dimensions in mm

SYSTEM CONFIGURATION	DVM6 C	DVM6 S	DVM6 A
	all manual, coded	standard, with motorized focus drive	advanced, motorized focus drive and motorized xy-stage
DVM6 zoom module	✓	✓	✓
Tilting stand	✓	✓	✓
XY-stage	manual	manual	✓
Focus drive	manual	✓	✓
LAS X SOFTWARE			
Parameter recall	✓	✓	✓
HDR	✓	✓	✓
Image preview	✓	✓	✓
Autofocus	—	✓	✓
Multifocus images	manual	✓	✓
3D surface image	—	✓	✓
XY-stitching	manual	manual	✓
XYZ-stitching	manual (no 3D)	manual (no 3D)	✓
Annotations	✓	✓	✓
2D Measurement (distance, area, angle)	✓	✓	✓
3D Measurement (distance, area, angle, profile, volume)	—	✓	✓

### ZOOM MODULE

Camera	image sensor	1/2.3" CMOS, 3664 x 2748 Pixel
	image resolution	2MP (1600 x 1200)
		5MP (2592 x 1944)
		10MP (3664 x 2748)
framerate (max)	37 fps @ 1600 x 1200 live image	
Autofocus	sensor	CMOS based sensor
	options	local or global
	modes	single autofocus, continuous autofocus
Iris diaphragm	motorized, software controlled	

### OBJECTIVES (according ISO/DIS 18221)

PlanAPO FOV 43.75	working distance: 60 mm	max. magnification: 190:1	max. resolution: 415 lp/mm
PlanAPO FOV 12.55	working distance: 33 mm	max. magnification: 675:1	max. resolution: 1073 lp/mm
PlanAPO FOV 3.60	working distance: 5 mm	max. magnification: 2350:1	max. resolution: 2366 lp/mm

### TILTING STAND

Tilt angle	max. ± 60°	tilt angle encoded and displayed
Handling	one handed (weight compensation)	
	0° index for home position	

### XY-STAGE

Travel range	70 mm x 50 mm
Resolution	1 µm
Rotation	max. ± 180°
Specimen weight (max load)	max. 2 kg

### FOCUS DRIVE

Travel range	60 mm
Resolution	0.25 µm (motorized)
	0.50 µm (manual)

### ILLUMINATION

Ringlight	integrated in objectives for the DVM6 LED light source, software controlled 4 segments switchable
Coaxial light	integrated in tilting stand, available for FOV 12.55 & FOV 3.60 objectives LED light source, software controlled
Transmitted light	cable-free insert for xy-stage (optional)
	LED light source, software controlled

### OPTIONAL ACCESSORIES

Ringlight adapters	diffusor low angle adapter polarizer
BLI for DVM6	transmitted light insert on xy-stage
Hand-/foot switch	
Interface module	connect DVM6 zoom module to Leica (M-series) focus column
Travel case	



# THE LEICA DVM6 DIGITAL MICROSCOPE



## 10-MEGAPIXEL CAMERA

---

- Fast live images
- High-resolution capture

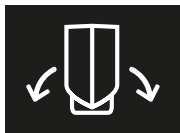

## EASY TILTING

---

- One handed operation for best ergonomy
- Simple and quick change of perspective



## PLANAPO OPTICS

---

- Magnification flexibility with 16:1 zoom range
- Image calibrated in every position

## DON'T SEARCH. FIND!

Leica Microsystems (Switzerland) Ltd. · Max-Schmidheiny-Strasse 201 · 9435 Heerbrugg, Switzerland  
T +41 71 726 34 34 · F +41 71 726 34 44

[www.leica-microsystems.com](http://www.leica-microsystems.com)